

MAESTRO



La polyvalence par excellence



Concept
Bureau



MAESTRO

La polyvalence par excellence.

La chaise MAESTRO est une gamme qui vous propose des sièges polyvalents, efficaces et fonctionnelles pour équiper des environnements : éducatif, communautaire ou de bureau.

Concept **Bureau**

Votre **Concepteur** d'Espace Professionnel

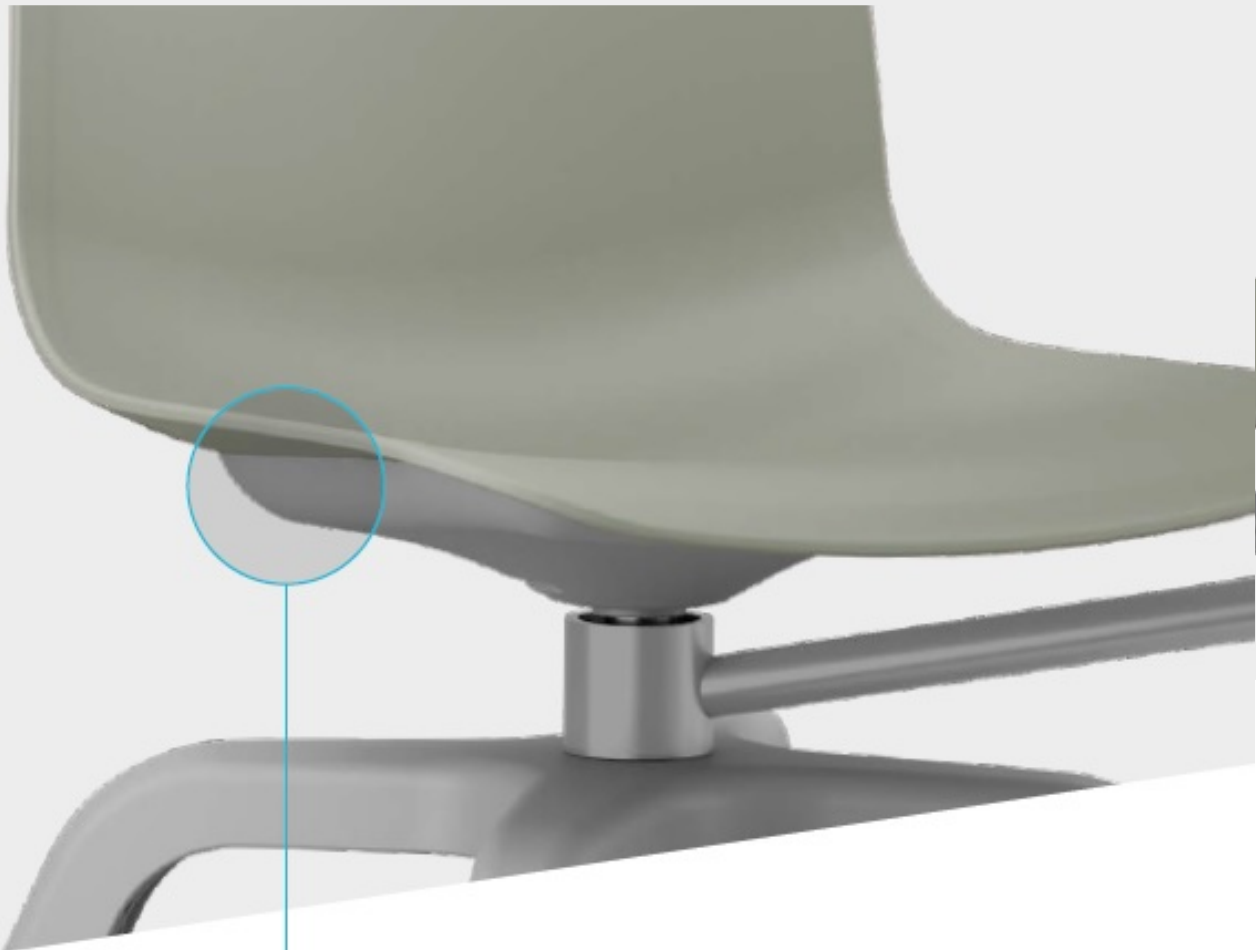

Un siège fin, peu encombrant et en même temps résistant.

Ergonomique et extrêmement confortable.

Facile à nettoyer grâce à sa forme de coque caractéristique.

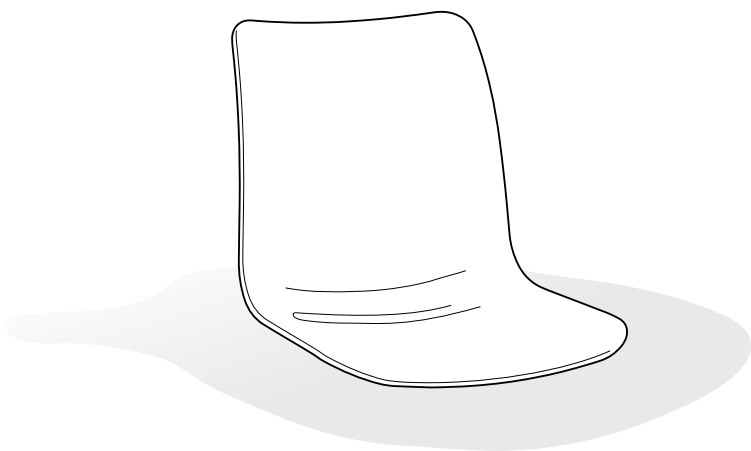

Un siège mince, qui prend peu de place et en même temps durable dans le temps.









ou

La coque est déclinée en 6 coloris tendances (Jaune, Bleu, Rouge, Mandarine, Vert, Gris)



Coloris disponibles:

	ORANGE P150U		Bordeaux
	BLEU RAL 5014		Marron
	ROUGE 527		Ivoire
	Gris		Mousse
	Jaune RAL 1012		Or
	Vert P556C		Sable

Concept Bureau

Education



Concept Bureau



La MAESTRO se distingue avec son panier de rangement et sa tablette écrivain rotative à 360°. Elle est idéale pour les centres de formation et les écoles.



ANSI · BIFMA

Conforme à la norme ANSI BIFMA X5.1: 2017

UNI EN 1729

Conforme à la norme UNI EN 1729-1 et 1729-2

ANSI · BIFMA

Conforme à la norme ANSI/BIFMA X5.1: 2017

UNI EN 1729

Conforme à la norme UNI EN 1729-1 et 1729-2

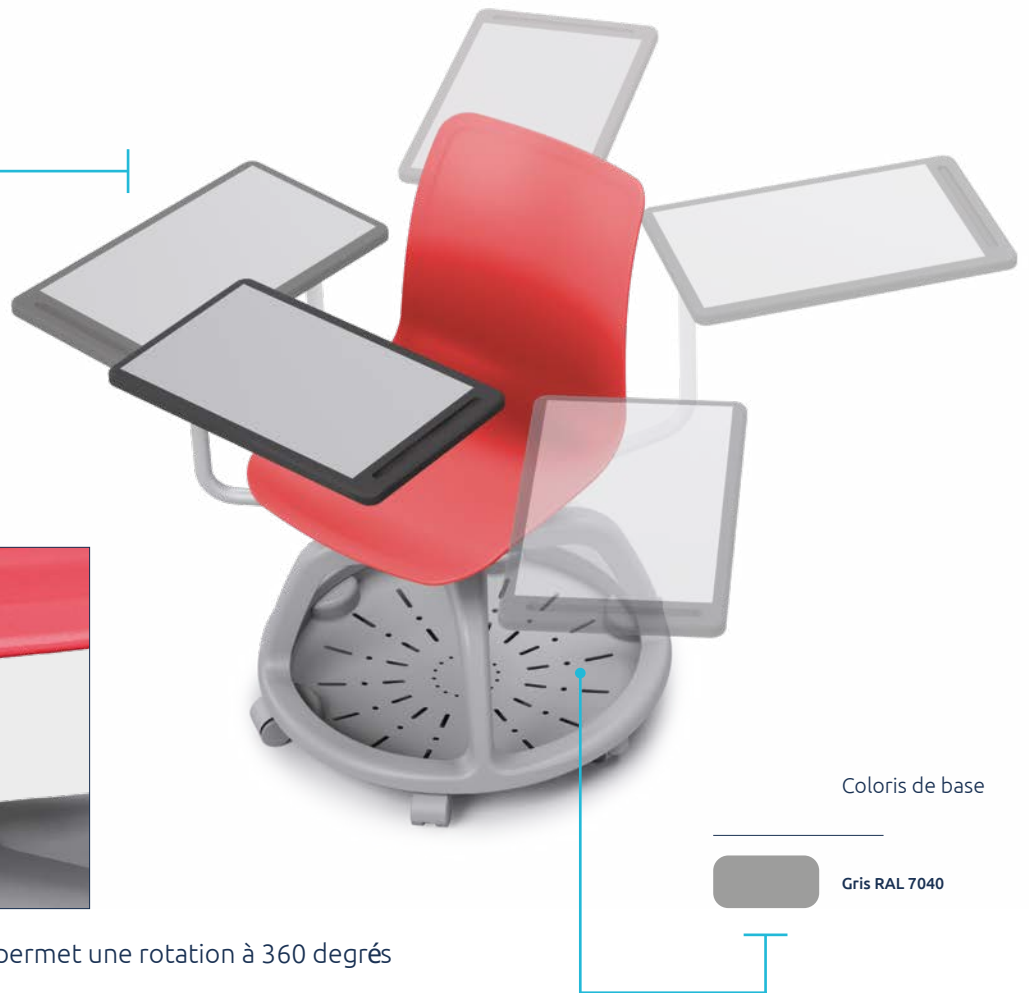

- Un support dédié permet une rotation à 360 degrés



- **Dimensions de la chaise :**
 - Hauteur totale: 85cm
 - Largeur totale: 63cm
 - Profondeur totale: 84cm
 - Assise : L45,1cm
 - Hauteur d'assise : 45cm
 - Hauteur tablette : 70cm
 - Hauteur utile du panier : 22cm
 - Diamètre panier : 63cm
- **Dimensions de la tablette :**
 - Largeur : 50cm
 - Profondeur totale: 30cm

NORMES:

- Conforme à la norme européenne ANSI
- Conforme à la norme BIFMA X 5.1 : 2017



Également disponible dans une version sans tablette d'écriture et avec la possibilité d'inclure un placet d'assise pour répondre au plus large éventail de besoins possible.



EDUCATION



Concept
Bureau



*Egalement disponible avec un piétement 5 branches sur
roulettes*

—



- Un support dédié permet une rotation à 360 degrés









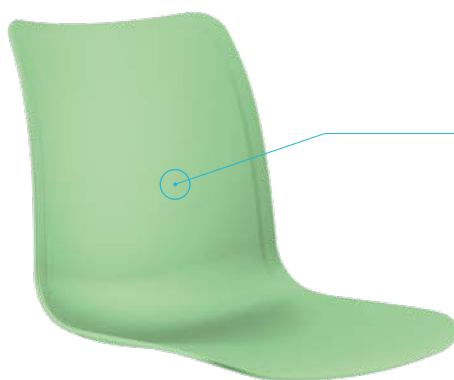

Coque en polypropylène

Platine de soutien



Colonne giratoire

Panier monté sur roulettes

11.34.001.99G



Coloris disponibles:



ORANGE P150U



BLEU RAL 5014



ROUGE 527



Gris



Jaune RAL 1012



Vert P556C



Bordeaux



Marron



Ivoire



Mousse



Or



Sable

Concept
Bureau

www.concept-bureau.fr
